

THE Honey^M PLUS⁺ MODULE

TSM-DD05A.08 (II)

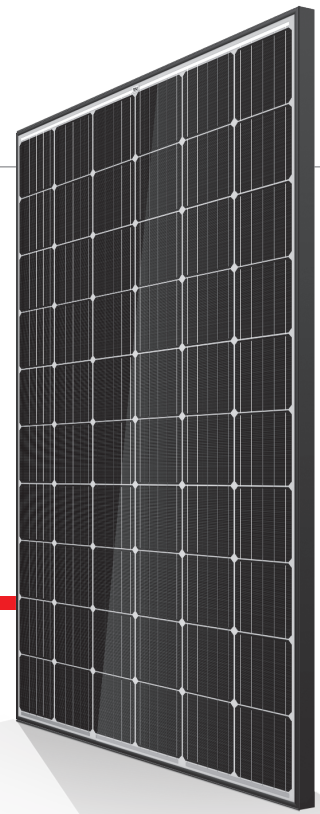

60 CELL

MONOCRYSTALLINE MODULE

275–295W

POWER OUTPUT RANGE

18.0%

MAXIMUM EFFICIENCY

0/+5W

POSITIVE POWER TOLERANCE

TRINA SOLAR: A STRONG AND RELIABLE PARTNER

As a leading global manufacturer of next generation photovoltaic products, Trina Solar is committed to building mutually beneficial alliances with installers, developers, distributors and technological partners as the backbone of our shared goal to drive Smart Energy Together. Thanks to an extensive sales and service network with local expert teams throughout Europe, Trina Solar is perfectly positioned to support your needs. With Trina Solar as your strong, bankable partner you can rest assured knowing that you've made the right choice.

www.trinasolar.com



Excellent low light performance on cloudy days, mornings and evenings

- Back surface field
- Advanced Honey surface texturing
- Selective emitter



Maximize limited space with top-end efficiency

- Up to 180 W/m² power density
- Low thermal coefficients for greater energy production at high operating temperatures



Good aesthetics for residential applications

- Dark mono cells
- Black frame



Highly reliable due to stringent quality control

- Over 30 in-house tests (UV, TC, HF, and many more)
- In-house testing goes well beyond certification requirements
- All modules have to pass electroluminescence (EL) inspection
- PID resistant
- 1000V UL/1000V IEC certified



Certified to withstand challenging environmental conditions

- 2400 Pa wind load
- 5400 Pa snow load
- 35 mm hail stones at 97 km/h
- Ammonia resistance
- Salt mist resistance
- resistance to sand and dust abrasion

LINEAR PERFORMANCE WARRANTY

10 Year Product Warranty • 25 Year Linear Power Warranty

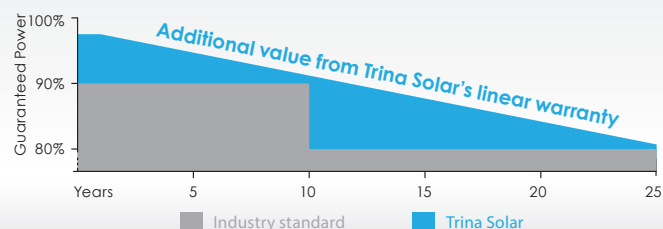

DIMENSIONS OF PV MODULE TSM-DD05A.08 (II)
(unit:mm)

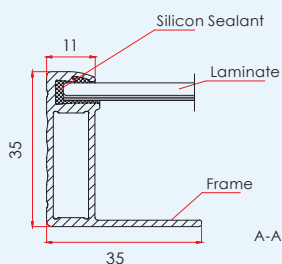
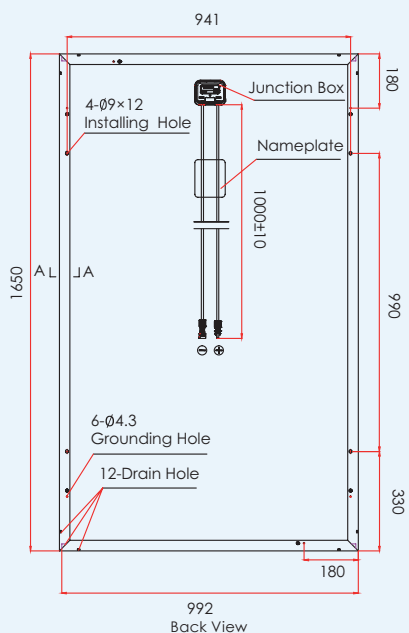

I-V CURVES OF PV MODULE (295W)

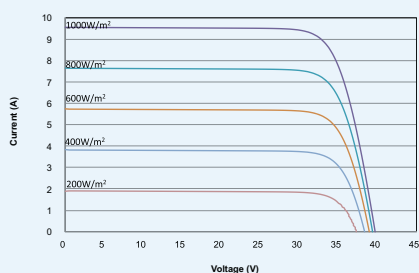

P-V CURVES OF PV MODULE (295W)

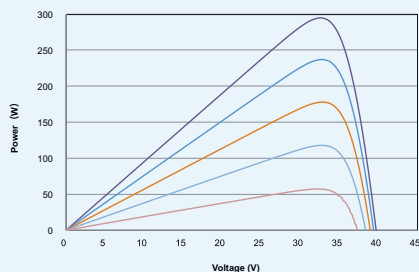

CERTIFICATION

IEC61215/EN61215
IEC61730/EN61730
IEC 627162 PfG 1917/05.11
IEC 61701
DIN EN 60068-2-68 LC2
MCS BRE PV0183

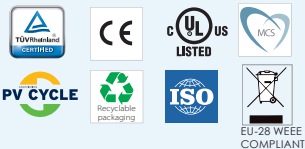

ELECTRICAL DATA @ STC	TSM-275 DD05A.08 (II)	TSM-280 DD05A.08 (II)	TSM-285 DD05A.08 (II)	TSM-290 DD05A.08 (II)	TSM-295 DD05A.08 (II)
Peak Power Watts- P_{MAX} (Wp)*	275	280	285	290	295
Power Output Tolerance- P_{MAX} (W)	0/+5	0/+5	0/+5	0/+5	0/+5
Maximum Power Voltage- V_{MPP} (V)	31.4	31.7	31.8	32.2	32.5
Maximum Power Current- I_{MPP} (A)	8.76	8.84	8.97	9.01	9.08
Open Circuit Voltage- V_{OC} (V)	38.7	39.0	39.3	39.5	39.7
Short Circuit Current- I_{SC} (A)	9.26	9.35	9.45	9.50	9.55
Module Efficiency η_m (%)	16.8	17.1	17.4	17.7	18.0

STC: Irradiance 1000 W/m², Cell Temperature 25 °C, Air Mass AM1.5
* Measuring tolerance: ±3%

ELECTRICAL DATA (NOCT)	TSM-275 DD05A.08 (II)	TSM-280 DD05A.08 (II)	TSM-285 DD05A.08 (II)	TSM-290 DD05A.08 (II)	TSM-295 DD05A.08 (II)
Maximum Power- P_{MAX} (Wp)	205	209	212	216	220
Maximum Power Voltage- V_{MPP} (V)	29.2	29.4	29.6	29.9	30.2
Maximum Power Current- I_{MPP} (A)	7.02	7.10	7.17	7.23	7.28
Open Circuit Voltage- V_{OC} (V)	36.0	36.3	36.6	36.7	36.9
Short Circuit Current- I_{SC} (A)	7.48	7.55	7.63	7.67	7.71

NOCT: Irradiance at 800 W/m², Ambient Temperature 20 °C, Wind Speed 1 m/s.

MECHANICAL DATA

Solar cells	Monocrystalline 156 × 156 mm (6 inches)
Cell orientation	60 cells (6 × 10)
Module dimensions	1650 × 992 × 35 mm (65.0 x 39.1 x 1.38 inches)
Weight	18.6 kg
Glass	3.2 mm (0.13 inches), High Transmission, AR Coated Tempered Glass
Backsheet	White
Frame	Black anodized aluminium alloy
J-Box	IP 67 or IP 68 rated
Cables	Photovoltaic Technology Cable 4.0mm ² (0.006 inches ²), 1000 mm (39.4 inches)
Connector	MC4 Compatible

TEMPERATURE RATINGS

Nominal Operating Cell Temperature (NOCT)	44K (± 2K)
Temperature Coefficient of P_{MAX}	- 0.39%/K
Temperature Coefficient of V_{OC}	- 0.29%/K
Temperature Coefficient of I_{SC}	0.05%/K

MAXIMUM RATINGS

Operational Temperature	-40 to +85°C
Maximum System Voltage	1000V DC (IEC) 1000V DC (UL)
Max Series Fuse Rating	15 A
Mechanical load	5400 Pa
Wind load	2400 Pa

WARRANTY

10 year Product Workmanship Warranty

25 year Linear Power Warranty

(Please refer to product warranty for details)

PACKAGING CONFIGURATION

Modules per box: 30 pieces

Modules per 40' container: 840 pieces

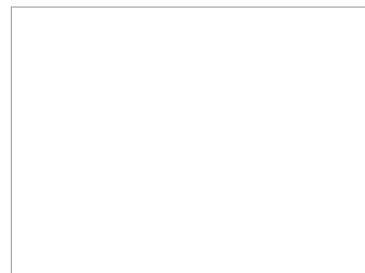

TSM_EN_2016_C